

GIUNZIONI

Ø 10

ART. BO04 - BO05 - BO29

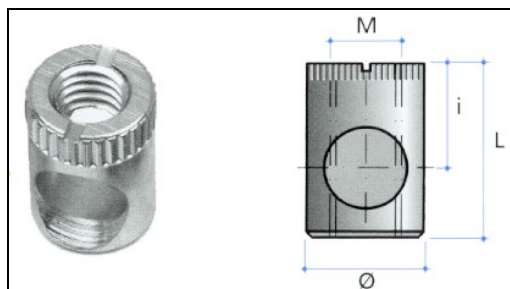

	ART.	Ø mm	L mm	MA	I mm	Finitura	PZ. Conf.
SENZA BORDO	BABO04ZI	10	13	6MA	8	Zincato	1/1250
	BABO05ZI	10	14	6MA	9	Zincato	
	BABO29ZI	10	19	6MA	14	Zincato	

PER Materiale - Ferro

ART. TF02 - TF04

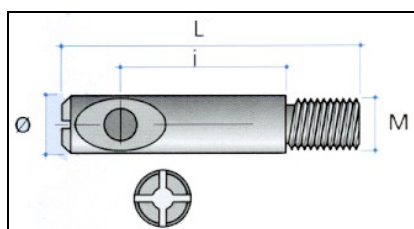

ART.	Ø mm	L mm	MA	I mm	Finitura	PZ. Conf.
PETF02ZI	7	36	6MA	20	Zincato	1/1000
PETF04ZI	7	45	6MA	30	Zincato	1/1500

PER Materiale - Ferr

ART.TFD7

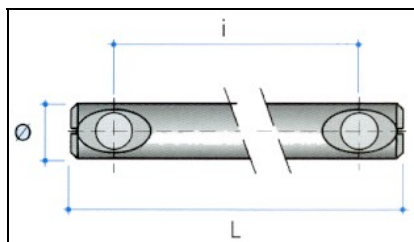

ART.	Ø mm	L mm	MA	I mm	Finitura	PZ. Conf.
PETFD7ZI	7	62		42	Zincato	1/1000

PER Materiale - Ferro

ART.GR 06

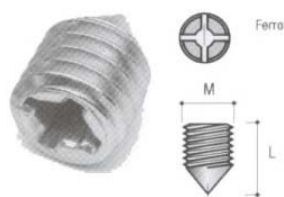

ART.	L mm	MA	MATERIAL E	Finitura	PZ. Conf.
VCGR06ZI	8	6MA	FERRO	Zincato	10000

GIUNZIONI

Ø 14

ART. 172

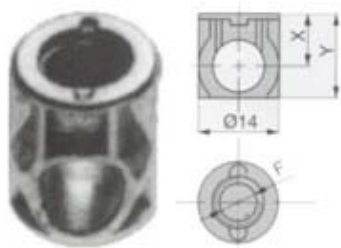

	ART.	Ø mm	Y mm	MA	X mm	Finitura	PZ. Conf.	EURO €
SENZA BORDO	BA172ZI	14	14,5	8MA	9	Zincato	1/1250	0,06456

PER Materiale - Zama

ART. 170

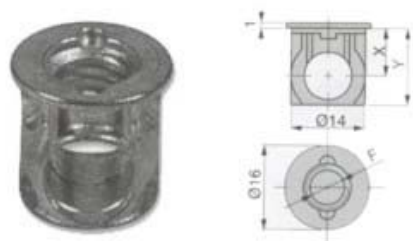

	ART.	Ø mm	Y mm	MA	X mm	Finitura	PZ. Conf.	EURO €
CON BORDO	BA170ZI	14	14,5	8MA	9	Zincato	1/1250	0,06456

Materiale - Zama

ART. TF02 – TF04

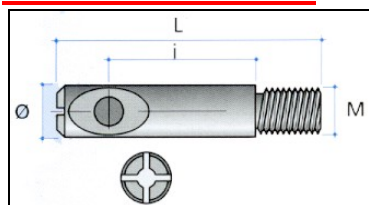

ART.	Ø mm	L mm	MA	I mm	Finitura	PZ. Conf.	EURO €
PETF02ZI	7	36	6MA	20	Zincato	1/1000	0,05165
PETF04ZI	7	45	6MA	30	Zincato	1/1500	0,05836

Per Materiale - Ferro

ART. TFD7

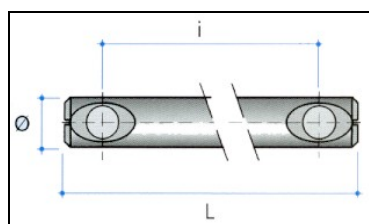

ART.	Ø mm	L mm	I mm	Finitura	PZ. Conf.	EURO €
PETFD7ZI	7	62	42	Zincato	1/1000	0,12085

Materiale - Ferro

ART. GR 01 - 1462

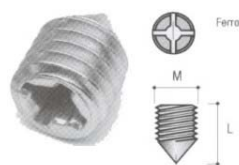

ART.	L mm	MA	Materiale	Finitura	PZ. Conf.	EURO €
VCGR09ZI	8	8	FERRO	Zincato	1/5000	0,01704

ART. 365

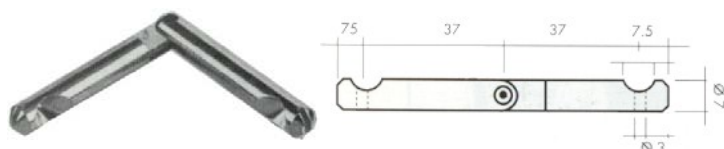

ART.	L mm	Finitura	PZ. Conf.	EURO €
PE365ZI	89	Zincato	1/500	0,93

Materiale - Ferro

ART. BO03- BO13

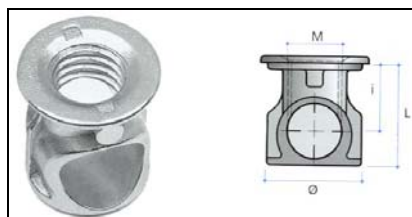

	ART.	Ø mm	L mm	MA	I mm	Finitura	PZ. Conf.
CON BORDO	BA003ZI	16	19,5	10M A	12,5	Zincato	1/1000

PER **Materiale** - Zama

ART. 338



	ART.	Ø mm	Y mm	MA	X mm	Finitura	PZ. Conf.
SENZA BORDO	BA338ZI	16	20	10M A	12,5	Zincato	1/1250

TEC **Materiale** - Zama

ART. TF05 – TF06 - TF08

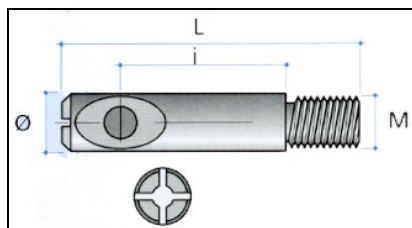

ART.	Ø mm	L mm	MA	I mm	Finitura	PZ. Conf.
PETF05ZI	10	36	6MA	20	Zincato	1/1000
PETF06ZI	10	36	8MA	20	Zincato	1/1000
PETF08ZI	10	46	8MA	30	Zincato	1/1000

PER **Materiale** - Ferro

ART.TFD10

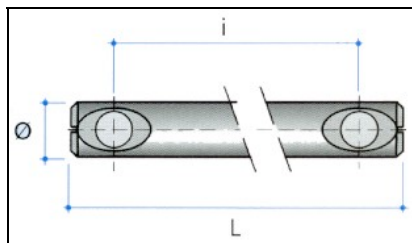

ART.	Ø mm	L mm	MA	I mm	Finitura	PZ. Conf.
PETFD10ZI	10	80		60	Zincato	1/500

TEC **Materiale** - Ferro

ART.GR 05

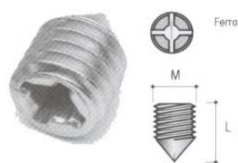

ART.	L mm	MA	Materiale	Finitura	PZ. Conf.
VCGR05ZI	12,5	10 MA	ZAMA	Zincato	1/5000

ART. GIUNTO MIFIX 15

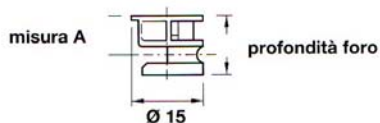

ART.	Per spessore	Ø mm	Finitura	PZ. Conf.	Descrizione
GI533NI	16	15	Nichel.	1-100	S/bordo
GI535NI	19	15	Nichel.	1-100	S/bordo
GI25535NI	19	15	Nichel.	1-100	C/bordo
GI536NI	23	15	Nichel.	1-100	S/bordo

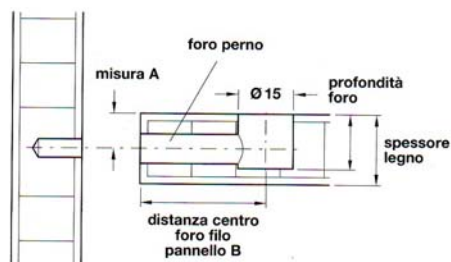
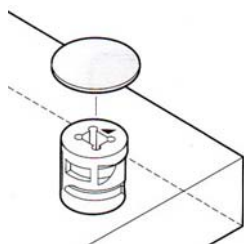

ART. Perno per giunti

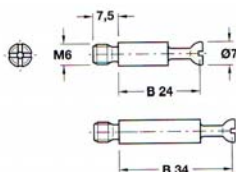

ART.	Lungh. mm	Ø mm	Finitura	PZ. Conf.
PE949ZI	24	7	Zinc.	1-100-1000
PE946ZI	34	7	Zinc.	1-100-1000

ART. Copri giunto

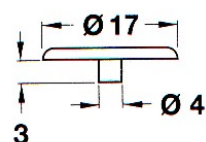

	ART.	Ø mm	Colore	PZ. Conf.
262.24.751	CO751BI	17	Biano	1-500
262.24.055	CO055PI	17	Pino	1-500
262.24.153	CO153MA	17	Marrone	1-500
262.24.359	CO359NE	17	Nero	1-500

ART.500

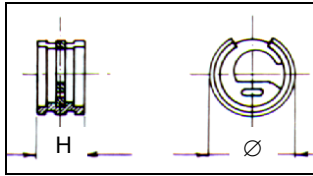

ART.	H mm	Ø mm	Finitura	PZ. Conf.
EC500105ZI	105	26	Zincata	1/100
EC500145ZI	145	26	Zincata	1/100

ART.500

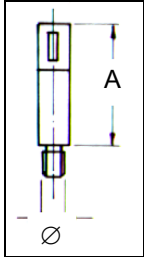
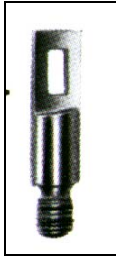

Filetto M6

ART.	A mm	Ø mm	Finitura	PZ. Conf.
PE50021ZI	21	7,5	Zincata	1/100
PE50032ZI	32	7,5	Zincata	1/100

ART.500

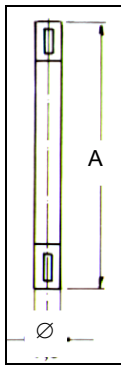
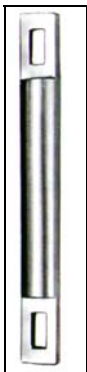

ART.	A mm	Ø mm	Finitura	PZ. Conf.
PE50080ZI	80	7,5	Zincata	1/50
PE50068ZI	68	7,5	Zincato	1/50

ART.500



ART.	Ø mm	Finitura	PZ. Conf.
CO500MA	265	Marrone	1/100
CO500BI	265	Bianco	1/100
CO505BI	345	Marrone	1/100
CO505NE	345	Bianco	1/100

ART.2120

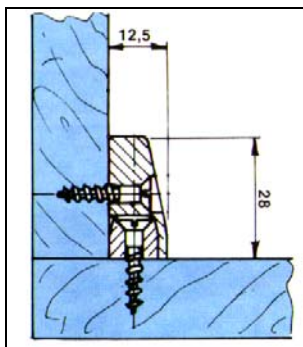

ART.	Finitura	PZ. Conf.
GI2120CO	Noce - Bianco	1/250

Giunzione keku da infilare
ART 359

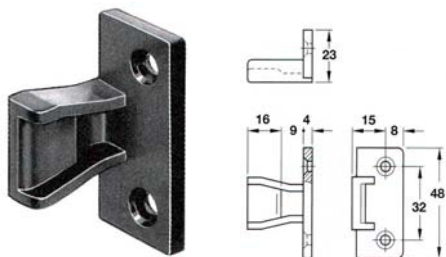

ART 368

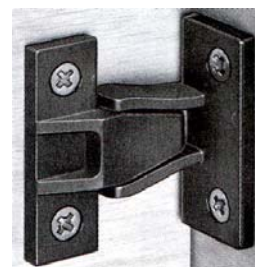
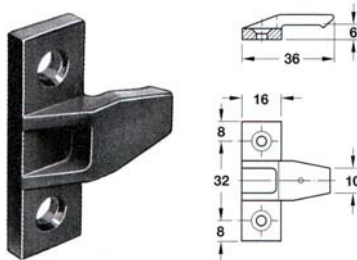

CODICE	PZ. Conf.
GP359NE	1-1000
GT368NE	1-1000

Giunzioni keku da incastro
ART 356

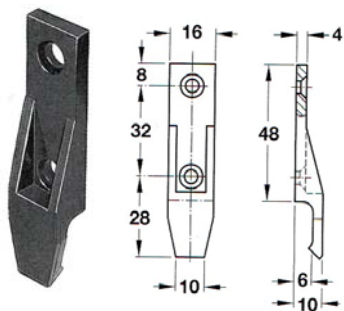

ART. 365

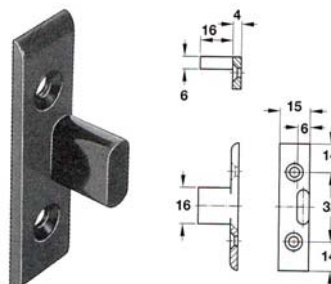

CODICE	PZ. Conf.
GP356NE	1-1000
GT365NE	1-1000